



**Operation and Maintenance Manual for the  
MBT360® Digital Soldering/Desoldering Rework System**  
Consisting of power source 7008-0341-01 or 7008-0341-02

**Manual 5050-0608**  
**Revision Date: 4/25/2022**  
For firmware version 1.3



## **TABLE OF CONTENTS**

General Information.....	1
Introduction.....	1
Specifications.....	1
Capabilities.....	2
MBT360 Compatible Handpieces.....	2
System Features.....	3
Safety Guidelines.....	4
Initial Set-Up.....	5
Attaching Tip & Tool Stand to MBT360.....	5
Instant SetBack Tool Stand Connection.....	5
Handpiece Connection.....	6
System Power.....	6
Basic Operation.....	7
Definitions.....	7
Operation.....	7
LED Indicator Meanings.....	7
Temperature Adjust Mode.....	8
Tip-Heater Cartridge Temperature Match Offset.....	8
SensaTemp Temperature Offset.....	9
Factory Settings.....	9
Customizing Your System.....	9
Entering Set-Up Mode.....	9
Password.....	9
Temperature Scale.....	10
Temperature Limits.....	10
Automatic Setback Timer.....	11
SetBack Reset.....	11
AutoOff.....	12
SetBack Temperature.....	12
Temperature Match Offset Control Mode.....	12
LCD Contrast.....	13
LED Backlite.....	14
Exiting Set-Up Mode.....	14
Corrective Maintenance.....	14
Power Source.....	14
Display Message Codes.....	15
Spare Parts.....	15
Optional AccuDrive® Blue Series Tip-Heater Cartridges.....	16
Service.....	16
PACE LIMITED WARRANTY STATEMENT.....	17

## **General Information**

### **Introduction**

Thank you for purchasing the PACE model MBT360 Desoldering & Rework System. This manual will provide you with the information necessary to properly set up, operate and maintain your new system, please read it thoroughly.

The MBT360 allows for continuous use of up to three handpieces using the two AccuDrive power ports and the SensaTemp power port. The MBT360 offers the reliability of SensaTemp and the speed of AccuDrive in a single system.

PACE's legendary SensaTemp technology is renowned for temperature stability and capability for high thermal mass applications. When dealing with smaller components or situations calling for high throughput, there is AccuDrive. The technology that boasts the best response time for high volume applications and easily keeps up in a fast-paced environment.

The MBT360 unit is available in either 120 VAC or 230 VAC versions. The 230 VAC version system bears the CE Conformity Marking which assures the user that it conforms to all the requirements of (EU) directive EMC 89/336/EEC & 73/23/EEC.

### **Specifications**

#### **Power Requirements**

**MBT360** - Operates on 108-132 VAC, 50/60 Hz. 300 Watts RMS at 120 VAC.

**MBT360 E** - Operates on 207-265 VAC, 50 Hz. 300 Watts RMS at 230 VAC.

#### **Physical Parameters**

**Size:** 13.5 cm H x 16.5 cm W x 26 cm D (5.3"H x 6.5"W x 10.25"D)

**Weight:** 6 Kg. (13 Lbs.)

**Vacuum Rise Time:** Less than 200 milliseconds to pull 254mm/Hg (10 in/Hg) vacuum on a 33 cubic centimeter (2 cubic inch) reservoir.

**Vacuum:** 880mbar (26 in. Hg.) Nominal

**Pressure:** 28 KPa (4 P.S.I.) Nominal MAXIMUM setting

**Air Flow:** 9 SLPM (0.32 SCFM) MAXIMUM

#### **Temperature Specifications**

**Tip Temperature Range:** 38-482 °C (100-900 °F) SensaTemp, 177-454 °C (350-850 °F) AccuDrive

**Digital Readout Resolution:** ±1° (°C or °F)

**Tip Temperature Stability:** ±1.1°C (2°F) at Idle from Set Tip Temperature.

**Temperature Accuracy:** Meets or exceeds ANSI JSTD 001

#### **NOTE**

Minimum and Maximum Operating Tip Temperatures as measured at the tip may vary depending on handpiece & tip selection.

#### **EOS/ESD Specifications**

**Tip-To-Ground Resistance:** Less than 2 ohms.

**AC Leakage:** Less than 2 Millivolts RMS from 50 Hz to 100 MHz.

#### **Environmental Requirements**

**Ambient Operating Temperature:** 0°C to 40°C (32°F to 104°F)

**Storage Temperature:** -40°C to 100°C (-40°F to 212°F)

## **Capabilities**

All capabilities are dependent on use of the appropriate accessories. Available handpieces and their functions are listed below. A manual is available for each handpiece with descriptions of the applications and recommended procedures for that tool.

The MBT360 allows a total of two AccuDrive handpieces and one SensaTemp to be plugged into the continuously active Power Ports on its front. The dual-purpose vacuum/pressure pump system with PACE's patented SNAP-VAC Technology, provides the most vacuum available for desoldering applications. When used with an air pencil, the pressure control valve allows for precise adjustment for working with the smallest components.

## **MBT360 Compatible Handpieces**

### **AccuDrive**

**TD-200 handpiece** – The most responsive soldering iron available. Uses tip-heater cartridges. TD-200 Kit P/N 6993-0316-P1 Handpiece only P/N 6010-0166-P1

**MT-200 handpiece** – Tip heater cartridge tweezers for SMD removal. MT-200 Kit P/N 6993-0323-P1 Handpiece only P/N 6010-0169-P1

### **SensaTemp**

**PS-90 Soldering Iron**– Provides a wide range of SMD and thru-hole installation and removal capability as well as unsurpassed thermal performance on heavy, multilayer thru-hole assemblies at safe, lower working temperatures. A wide variety of 3/16" shank, quick change thru-hole and SMD tips (for chip components, SOTs, SOICs and other components) are available. PS-90 Kit P/N 6993-0199-P1 Handpiece only P/N 6010-0131-P1

**SX-100 Sodr-X-Tractor handpiece** – Air handpiece ideal for thru-hole desoldering on high-mass multilayer boards. SX-100 Kit P/N 6993-0213-P1 Handpiece only P/N 6010-0106-P1

**TT-65 ThermoTweez handpiece** – Performs removal of PLCC (J Leaded), LCCC (leadless) and other surface mount devices. TT-65 Kit P/N 6993-0207-P1 Handpiece only P/N 7025-0001-P1

**TJ-70 Thermo Jet handpiece** – Finger switch activated precision air pencil for the installation or removal of SMDs. TJ-70 Kit P/N 6993-0206-P1 Handpiece only P/N 7023-0002-P1

### **Handpiece Tips**

A complete list of tips is available from your local PACE distributor or online at [www.paceworldwide.com](http://www.paceworldwide.com).

## System Features

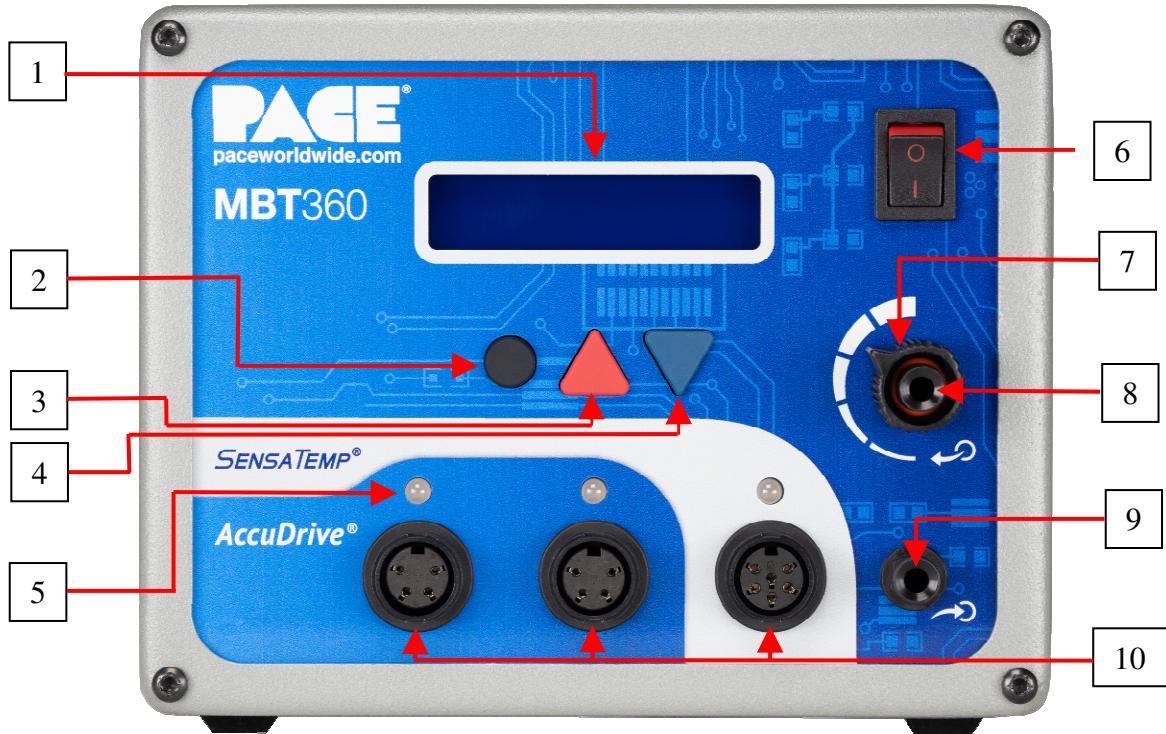

Figure 1

Listed below is a description of the Control Panel features. Use Figures 1 & 2 as a guide.

1. **LIQUID CRYSTAL DISPLAY** - Provides temperature information for all three channels.
2. **PROGRAM KEY** – Used to accept settings and to scroll through system channels.
3. **SCROLL UP KEY** - Increases the Set Tip Temperature or the Tip Temperature Offset in increments of one, then ten-degree increments when held down. Also used to “wake up” the machine from SetBack.
4. **SCROLL DOWN KEY** - Decreases the Set Tip Temperature in one, then ten-degree increments. Also used to navigate menu options.
5. **LED:** CH 1, CH 2 or CH 3 Illuminated LED’s change color to reflect handpiece connectivity. GREEN (circuit complete) AMBER (in process) RED (no connection / error)
6. **POWER SWITCH** - Turns system ON (“1”) and OFF (“0”); controls input power to the system.
7. **PRESSURE ADJUSTMENT** – Controls the amount of pressure of airflow delivery.
8. **PRESSURE PORT** – Quick connect fitting which provides airflow for ThermoJet handpiece. Air pressure will blow for a minimum of 1.2 seconds after activation and will remain active after that for as long as the switch or foot pedal is depressed.
9. **AUTO SNAP-VAC PORT** - Quick connect fitting provides quick-rise vacuum for Sodr-X-Tractor, and ThermoPik handpieces. Vacuum is present for a minimum of 1.2 seconds after activation and will remain active after that for as long as the switch or foot pedal is depressed.
10. **CH 1 POWER RECEPTACLE** - Provides for connection of power, tip ground, and sensing circuitry between the MBT system and handpiece connected to Channel 1 (CH 1).  
**CH 2 POWER RECEPTACLE** – Provides for connection of power, tip ground, and sensing circuitry between the MBT system and handpiece connected to Channel 2 (CH 2).  
**CH 3 POWER RECEPTACLE** - Provides for connection of power, tip ground, sensing circuitry, and finger switch input between the MBT system and handpiece connected to Channel 3 (CH 3).

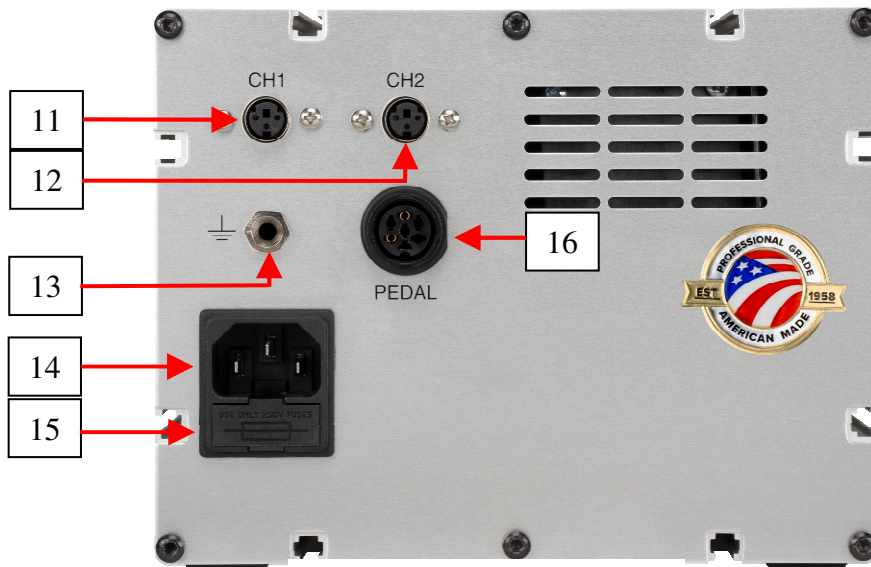

Figure 2

11. **INSTANT-SETBACK CUBBY INPUT CHANNEL 1.** Links handpiece on channel 1 to an Instant-Setback Cubby.
12. **INSTANT-SETBACK CUBBY INPUT CHANNEL 2.** Links handpiece on channel 2 to an Instant-Setback Cubby.
13. **EARTH GROUND RECEPTACLE** - Provides hard earth ground. A ground cable can be connected from the work piece or work surface as part of a static control program. **NOTE:** Ensure there is at least 1 MΩ of resistance between the earth ground and any connection to a user.
14. **AC POWER RECEPTACLE / FUSE HOLDER** - Receptacle for providing power to the system from AC outlet through a power cord.
15. **FUSE** - Provides overload protection for system.
16. **FOOT PEDAL RECEPTACLE** - Input for Foot Pedal (optional), which activates vacuum or pressure to the air-operated handpiece.

### **Safety Guidelines**

The following are safety precautions that personnel must understand and follow when using or servicing this product.

1. **POTENTIAL SHOCK HAZARD** - Repair procedures on PACE products should be performed by qualified service personnel. Line voltage parts may be exposed when the equipment is disassembled. Service personnel must avoid contact with these parts when troubleshooting the product.
2. Tip-Heater Cartridges, tips, and heater elements are hot when the handpiece is powered on and will remain so for some time after being powered off. **DO NOT** touch the heater or the tip. Severe burns may result.
3. PACE Tip & Tool Stands are designed specifically for use with the associated handpiece and houses it in a manner that protects the user from accidental burns.
4. Always use PACE systems in a well-ventilated area. Fume extraction systems, such as those available from PACE, are highly recommended to help protect personnel from solder flux fumes.
5. Exercise proper precautions when using chemicals (e.g., solder paste or flux). Refer to the Material Safety Data Sheet (MSDS) supplied with each chemical and adhere to all safety precautions recommended by the manufacturer.
6. **WARNING** - The handpiece must be placed into the cubby when not in use.
7. This equipment is not intended for use by persons (including children) with reduced physical, sensory, or mental capabilities, or lack of experience and knowledge, unless they have been given supervision or instruction concerning use of the equipment by a person responsible for their safety.

## **Initial Set-Up**

Set up the MBT360 system by doing the following.

1. Remove the unit from its shipping container. Store the shipping container(s) in a convenient location. Reuse of these containers will prevent damage if you ship or store the system.
2. Place the unit on a convenient workbench.
3. Ensure the POWER Switch (located on power source front panel) is in the "OFF" or "0" position.
4. Inspect all system components, check for shipping damage, and ensure that all purchased components (standard and optional) are present.
5. Assemble Tip & Tool Stands. Attach to the power source if desired using included hardware. Assembly instructions are enclosed with each Tip & Tool Stand.

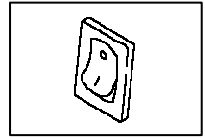

### **Attaching Tip & Tool Stand to MBT360**

Attach the stand to the side of the MBT360's chassis, using the following procedure. Refer to illustration.

1. Insert the two enclosed hex head Mounting Screws into the slot on the side of the chassis. Some kits may contain four mounting screws: two with small heads and two with large heads. Use the screws that fit properly in the slot. Also, some chassis may have more than one slot; use the lower slot.
2. Position the Mounting Screws to the rear of the chassis and spaced approximately two inches apart. Refer to illustration.
3. Place the Tip & Tool Stand beside the chassis. Insert ends of the two Mounting Screws into the two adjacent Tip & Tool Stand mounting holes.
4. Install a Thumb Nut onto the end of each Mounting Screw. Tighten Thumb Nuts to secure the Tip & Tool Stand in position. You may wish to set the Power Source on its side and remove the drip tray to ease installation of the Thumb Nut.
5. Additional Tip & Tool Stands, or "cubbies", may be secured to each other by aligning mounting holes on stand sides. Use provided hex head screws and thumb nuts to mount cubbies together.

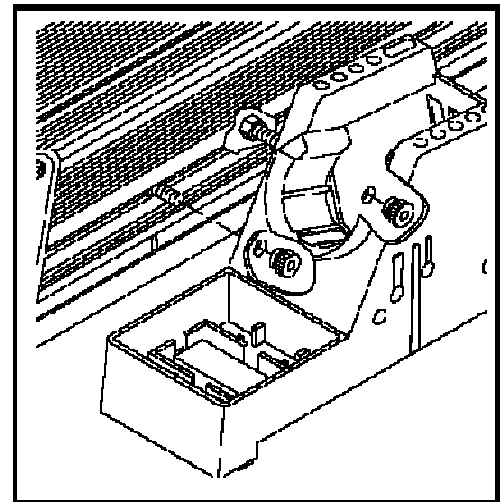

### **Instant SetBack Tool Stand Connection**

If your system includes an Instant SetBack Tool Stand (ISB cubby), follow the steps below.



1. Connect the cable from the ISB cubby to the appropriate receptacle on the rear panel of the power supply, being mindful of which channel each belongs to.
2. Position the tool stand on workbench within operator reach.
3. Insert tool loaded with Tip-Heater Cartridges into the tool stand.
4. When the handpiece is placed into the ISB cubby, Temperature Setback Mode will activate after 30 seconds. Lifting the handpiece from the stand will resume normal operation.

## Handpiece Connection

The MBT360 will work with AccuDrive or SensaTemp hand pieces and tip heater cartridges via the three channels on its front panel, two for use with AccuDrive hand pieces and one for use with SensaTemp tools.

**Caution:** Using handpieces from other PACE product lines may result in damage to the equipment. Only use tip heater cartridges from the AccuDrive collection (the ones with blue caps on the end). IntelliHeat tip heater cartridges (black end caps) or WJS-100 tip heater cartridges (yellow end caps) will not operate correctly with the MBT360.



1. Connect any AccuDrive 4-pin handpiece plug to the power receptacles CH 1 or CH 2 or any SensaTemp 6-pin handpiece plug to CH 3 by doing the following:
  - a) With the Connector Key end facing the power source, turn the Locking Ring fully counterclockwise.
  - b) Orient guide on connector with slot of power receptacle.
  - c) Insert connector into power receptacle.
  - d) Turn Locking Ring fully clockwise to lock in place.
2. To avoid confusion among handpieces, PACE recommends the use of colored cable markers (P/N 6993-0136 Cable Marker Kit) to identify each handpiece and its plug. Attach any two like colored markers, one to each end of the handpiece power cable or air hose. Select and use a different colored marker for each handpiece.
3. If you have purchased/received an optional foot pedal, insert the connector plug into the PEDAL Receptacle on the rear panel of the power source. Install additional handpieces and accessories as necessary.

## System Power

1. Insert the female end of the power cord into the AC Power Receptacle on the rear panel of the power source.
2. Plug the prong end (male end) of the power cord into an appropriate 3 wire grounded AC supply receptacle.





## Basic Operation

### Definitions

Please familiarize yourself with the definitions of each of the following terms.

**Auto-Off:** Safety feature that turns the power to the irons off after the system has entered Temperature Setback. (1-90 minutes, settable in 1-minute increments)

**Normal Operation:** Normal operating mode of the system in which the Operating Tip Temperatures are displayed.

**Password:** The Password feature of the system will prevent unauthorized alteration of stored system parameters and features. If a Password has been installed, the display will show an instruction to enter the password. Enter the four-digit number by using the scroll up /down keys on the system front panel.

**Setup Mode:** The interface used to program the system features and parameters (e.g., temperature limits, password, setback time).

**Set Temperature:** The operator selected tip temperature stored in the system memory.

**Temperature Adjust Mode:** Mode of operation where the Set Temperature may be adjusted.

**Temperature SetBack:** System feature that will “set back” the temperature of the iron to a lower value after a set period of inactivity has been detected by the system. The SetBack temperature and time are both customizable by the user, refer to the section on Customizing Your System for more information.

### Operation

1. Ensure the Set-Up procedure has been performed. Check the following:
  - Handpiece connection to the power source.
  - Proper Tip-Heater Cartridge or tip is installed in each handpiece.
  - Power cord is connected to both an appropriate AC supply and the unit.
2. Turn the Power Switch On ("I").
3. The Set Temperature will be displayed after the brief start-up sequence.
4. Adjust the tip temperature by pressing and holding Scroll Up Key (▲) or Scroll Down Key (▼) to adjust the temperature and the Program Key (●) to switch channels. The Set Temperature increases/decreases in 1° increments at first, then increments of 10°. Release the key when desired temperature has been set.



**NOTE:** The Set Temperature can only be adjusted within the upper and lower temperature limits. If the lower limit is reached, the display will read “OFF”. Temperature limits can be adjusted in the Set-Up menu. Refer to section Customizing Your System for more information.

### LED Indicator Meanings

The Amber, Red and Green tri-colored LEDs on the front panel of the power source indicate the status of attached handpiece(s) as follows.

LED is Green - Indicates the set tip temperature has been reached for this channel. Power to the handpiece is cycling to maintain the temperature set point.

LED is Steady Amber - Continuous power is being delivered to the handpiece. This condition is evident when the system is first powered up (handpiece heater cold) or the temperature setting is increased.

LED is Blinking Amber – The associated channel has gone into Temperature Setback, preserving the lifespan of tips and heater elements by lowering the temperature.

LED is Red - No power is being delivered to the indicated channel. If the LED never illuminates, check for a faulty handpiece heater.

LED is Off – The handpiece is turned off, disconnected, or there is an error.

### **Temperature Adjust Mode**

To increase or decrease handpiece temperature, press the Scroll Up Key (▲) or Scroll Down Key (▼) once, and the display will change to Temperature Adjust Mode. In this mode the display will show the current temperature setting for channel 1. Press the Scroll Up Key (▲) or Scroll Down Key (▼) to increase or decrease handpiece temperature, in real time, for channel 1 as desired then press the Program Key (●) to move the next channel and repeat for channels 2 and 3. After a short period of inactivity, the display will return to normal operation.

### **Tip-Heater Cartridge Temperature Match Offset**



When a hand tool is connected to Channel 1 or Channel 2 and there isn't a Temperature Match Offset saved, the "C" in channel ("CH") will be free of any indicator dot in the center of the "C". Anytime a Temperature Match Offset is in use on Channels 1 or 2, there will be a STEADY or BLINKING indicator dot in the C, as seen in the image at right on Channel 1. The Temperature Match Offset only applies to AccuDrive, channels 1 & 2.

Explanation of how to change SensaTemp offset used for Channel 3 is discussed in the next section.

To enter a Temperature Match Offset value, perform the following steps.

1. Turn on the system.
2. Clear any existing offset by disconnecting the handpiece from the system. Re-connect the handpiece. After doing this, the display "CH" for channels 1 and 2 should not have any indicator dot inside of the "C".
3. Set the temperature to 700°F (370°C).
4. Measure the temperature of the tip with the temperature verification device of your choice and note the results for later use.
5. Turn off the system in preparation to enter the Temperature Match Offset.
6. Press and hold the Program Key (●) and the Scroll Up Key (▲) while turning the system on. Release both keys when the software version appears.
7. The display will show "Channel 1 System Cal?". Press the Scroll Up Key (▲) to select "Yes" and continue entering a temperature offset for Channel 1 or press the Scroll Down Key (▼) for "No" and go to step 9.
8. After selecting Yes, the display will ask you to enter the actual tip temperature that was measured for Channel 1. Use the keypad (▲▼) to input the temperature and then save and continue to the next step by pressing the Program Key (●) when done.
9. The display will ask "Channel 2 System Cal?" Press the Scroll Up Key (▲) to select "Yes" and continue to entering a temperature offset for Channel 2 or press the Scroll Down Key (▼) to select "No" and return to normal operating mode.
10. If "Yes" was chosen, the unit will ask you to "Enter Tip Temp." for Channel 2. Use the Scroll Up Key (▲) or Scroll Down Key (▼) to input the temperature measured during step 4. When done, press the Program Key (●) to return to normal operating mode.

## SensaTemp Temperature Offset

To access the menu for changing the temperature offset for SensaTemp tools, hold the Program Key (●) down for 5 seconds. The display will change to show “Set Offset Chan 1 = 000”. Pressing the Program Key (●) will change this to “Set Offset Chan 2 = 000”. Pressing the Program Key (●) one more time will change this to “Set Offset Chan 3 = 000”, where we can adjust the actual temperature of the tip upwards a maximum of 150°F. Use the keypad (▲▼) to increase or decrease the temperature offset. When finished press the Program Key (●) to return to normal operation or, after 5 seconds of inactivity, the system will return to normal operation on its own. The value for Channel 1 or 2 cannot be altered here as those are AccuDrive channels, refer to 11b under “Customizing Your System” for more details.

## Factory Settings

The MBT360 system is equipped with several features which may be adjusted by the user. Listed below are the default settings of each. To change and/or learn about any of these features, refer to the “Customizing Your System” section of this manual.

Feature	Factory Setting
Password	None Entered
Default Temperature Scale (°C/°F)	°F for 115 VAC Systems
	°C for 230 VAC Systems
“HI” Temperature Limit	427 °C (800 °F)
“LO” Temperature Limit	260 °C (500 °F)
SetBack Timer	30 minutes
SetBack Reset	Select (instead of all)

Feature	Factory Setting
Auto Off Timer	60 minutes
SetBack Temperature	177°C (350°F)
Temperature Match Mode	OS Mode = 1
Set LCD Contrast	50
Set LED Backlite	75
Set Temperature	371°C (700°F)
Temperature Match Value	“0”

## Customizing Your System

The menu driven user interface allows you to easily customize your system. In Set-Up Mode, you can:

- Enter, remove, or change a Password.
- Set the Default Temperature scale to °F or °C.
- Change the Upper and Lower Temperature limits.
- Enable or disable the Temperature Setback feature and adjust the time-out period (if enabled).
- Enable or disable the Auto Off feature and adjust the time-out period (if enabled).
- Adjust the temperature that the system goes to during Temperature SetBack.
- Change how the Temperature Match is stored or cleared.
- Manipulate the backlight and contrast of the LCD display for best visibility.

## Entering Set-Up Mode

The following instructions should be performed to familiarize the operator with the system. Note: No settings will be changed/saved until the end. If the unit is turned off before reaching the end, nothing will be changed.

- 1.** Place Power Switch in the “OFF” (“0”) position.
- 2.** Press and hold the Program Key (●) while turning the Power Switch on (“I” position). Release all keys when the software version is displayed.

## Password

A password can be used to secure the Set-up Menu from unauthorized access.

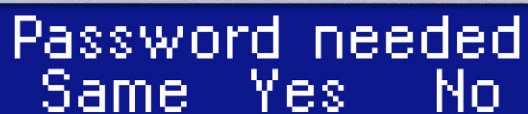

Password needed  
Same Yes No

3. The display will show the version of the microprocessor and change to read "Enter Password" or "Password needed".
  - If the display reads "Enter Password", a Password has been stored in system memory. The password must be entered to access the menu. If the wrong password is entered, "Wrong Password" will appear on the display and the system will return to normal operation. If this occurs, repeat steps 1 & 2 and enter the correct Password.
  - Once the display shows "Password needed". Choose one of the following options:
    - a. Press the Program Key (●) to keep the current password (whether one is saved or not) and move on to the next step.
    - b. Press the Scroll Up Key (▲) to select "Yes" and proceed to set a password by selecting a 4-digit number using the keypad (▲▼). Make a note of the entered password for future reference. Press the Program Key (●) to advance to the next setting.
    - c. Use the Scroll Down Key (▼) to select "No" and dispose of the currently stored password and move on to the next step.

### Temperature Scale

The MBT360 can display temperatures in Celsius or Fahrenheit.

4. The display now shows the stored default Temperature Scale, either °C or °F. Choose one of the following:



- Press the Program Key (●) to keep the stored default Temperature Scale.
- Use the Scroll Up Key (▲) to change the default Temperature Scale. Press and release the Program Key (●) to advance to the next setting.

### Temperature Limits

The allowable temperature range of the AccuDrive channels, Channel 1 and Channel 2, is between 177°C (350°F) and 454°C (850°F). The allowable temperature range of the SensaTemp channel, Channel 3, is between 38°C (100°F) and 482°C (900°F) The Low Temperature Limit cannot be adjusted higher than the High Temperature Limit. These limits control how high or low the Set Temperature can be adjusted to during normal operation.

5. The display will show the stored Upper Temperature Limits ("UL") for each of the three channels.

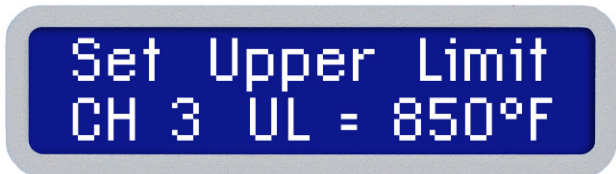

- Press and release the Program Key (●) to keep the current Upper Temperature Limit for the current Channel.
- Adjust the stored Upper Temperature Limit using the keypad. (▲▼) Cannot be adjusted below the Low Temperature Limit.
- Press and release the Program Key (●) to proceed to the next channel or next step once Channel 3 has been set.

6. The display now shows the stored default Lower Temperature Limit ("LL") for each of the three channels.



- Press and release the Program Key (●) to keep the stored Low Temperature Limit for that Channel.
- Adjust the stored Lower Temperature Limit using the keypad. (▲▼)
- Press and release the Program Key (●) to proceed to the next channel or the next step once Channel 3 has been set.

### Automatic Setback Timer

What is Temperature Setback? To preserve tip life and save energy, the system can automatically adjust the Set Tip Temperature to a lower value after a selected period of inactivity (factory setting of 30 minutes).

- 7.** The display will be showing “Set SetBack Time”. Time is shown in minutes and can be adjusted between 10 to 90 minutes in one minute increments. Attempting to enter a value less than 10 minutes will set the timer at 0. Leaving this setting on 0 will disable the Automatic SetBack which results in the irons running at the Set Temperature continuously unless an Instant SetBack cubby is also being used.



- Press and release the Program Key (●) to keep the currently stored Temperature Setback time.
- Adjust the stored Temperature Setback value using keypad. (▲▼)
- Press and release the Program Key (●) to proceed to the next step.

### SetBack Reset



The MBT360 may have more than one handpiece connected. SetBack Reset provides fine control of how each handpiece channel can be brought out of SetBack by selecting them individually or by returning all of them to normal operation at once.

- SB Reset = Sel – Allows users to selectively end SetBack on individual channels by first pressing the Scroll Up or Down Keys (▲▼) to enter Temperature Set Mode, then selecting the desired channel using Program Key (●) and finally using the Scroll Up Key (▲) or Scroll Down Key (▼) to end SetBack for that channel.
- SB Reset = All – Allows users to end SetBack on all channels at once by first pressing the Scroll Up or Down Keys (▲▼) to enter Temperature Set Mode then again pressing the Scroll Up Key (▲) or Scroll Down Key (▼) to exit SetBack on all channels.

Upon exit of SetBack, the unit will resume normal operations and the handpiece will heat up, returning to the Set Temperature.

- 8.** The display will show “SB reset = XXX” with “XXX” representing “Sel” or “All” meaning the unit will end SetBack on an individual channel **S**electively or on **A**ll of them.
- Change between Sel or All by using the Scroll Up Key (▲).
  - Press and release the Program Key (●) to keep the currently displayed option and continue to the next setting.

## AutoOff

When enabled, after the unit has entered Temperature SetBack, the AutoOff feature will turn off power to the handpieces once a predetermined amount of time (between 10- 90 minutes set by the user). When the system has entered Temperature Setback, an internal timer will start counting down.



Set AutoOff Time  
Time = 15 min

If any key is pressed during the AutoOff timer countdown, the AutoOff and Setback timers will reset. The system will return to normal operation. When/if the AutoOff timer reaches the end, the system will enter Auto Off. Power is turned off to the heater and the display will show “SDN” meaning the iron has been Set Down for an extended period and is turned off. **Exiting Auto Off:** To exit the AutoOff, first press and release the Scroll Up or Scroll Down keys (▲▼), then use the Program Key (●) to advance through the channels and again press the Scroll Up or Scroll Down keys (▲▼) to wake up the selected channel. Alternatively turning the Power Switch OFF (“0”) and then back ON (“1”) will reset all three channels back to normal operation.

- 9.** The display will show “Set AutoOff Time” and the current value as “Time = XX minutes” where XX can be any value from 0 to 90 in increments of 1 minute. A time of “0” will disable the AutoOff feature completely. Choose one of the following:
- Press and release the Program Key (●) to keep the currently stored Auto Off time.
  - Adjust the Auto Off value using the keypad (▲▼).
  - Press and release the Program Key (●) to proceed to the next step.

## SetBack Temperature

The temperature that the irons will cool down to once they entered into SetBack, can be adjusted.

- 10.** The display will show “Set Setback Temp” and underneath will be the current setting. The default value for this being 177°C (350°F) and can be set anywhere between 150°C (300°F) and 230°C (450°F).



Set SetBack Temp  
Temp = 350°F

- Press and release the Program Key (●) to keep the currently stored Instant SetBack temperature, or;
- Adjust the stored Instant Setback Timer value using keypad. (▲▼)
- Press and release the Program Key (●) to proceed to the next step.

## Temperature Match Offset Control Mode

- 11.** The display screen will show “Set Offset Mode” and “OS Mode =” and a number representing the current mode. Select the OS Mode using keypad (▲▼) to choose one of the following;



Set Offset Mode  
OS Mode = 1

- a. **“OS Mode 1” (Offset Mode 1)** Offset will clear to zero, which also clears the indicator dot, if the handpiece or the tip is removed from the system. This is the default setting from the factory.
- This option may be a good choice when using a variety of different tips or handpiece which require the system to be calibrated after each change
- b. **“OS Mode 2” (Offset Mode 2)** Offset will clear to zero if the handpiece is removed from the system, but only removing the tip will keep the current offset and the indicator dot will begin BLINKING. A

BLINKING dot will let the user know there is a Temperature Match value in use but that the setting may need verification.

- This option is desirable when using tips of similar geometry where it may not be necessary to formally recalibrate, but tip changes are still monitored/tracked.
  - This option would be desirable in situations where users want to easily determine if the tip has been removed/replaced.
- c. **“OS Mode 3” (Offset Mode 3)** Offset will clear to zero and remove the STEADY dot if the handpiece is removed from the system but removing only the tip will keep the current offset with no change to the indicator dot.
- As an example, this option could be selected in applications when the tip is rarely replaced or when the same style tip is used throughout the application.
  - This option is desirable if replacing the handpiece should require the system to be recalibrated.

Press and release the PROGRAM Key ● to proceed to the next step.

**11b.** If **“OS Mode 2”** was chosen, then you have one additional option. This option controls whether the calibration indicator dot can be reset, or if a new Temperature Match Offset value must be entered to restore the indicator dot to the STEADY on state. The screen will show “OS mode 2 Reset?” with the following choices:



- **ON** - The line operator/user can reset the indicator dot. To reset, hold down the Program Key (●) for 5 seconds to bring up the SensaTemp Offset screen. If done correctly, the screen will show “Set Offset Chan 1 = 000”. Pressing the Scroll Up Key (▲) will reset the indicator dot for Channel 1. Pressing the Program Key (●) again will advance to Channel 2, where pressing Scroll Up Key (▲) will reset the indicator dot for Channel 2. If nothing is pressed for 8 seconds, the unit will resume normal operation, or press the Program Key (●) to advance the menu past Channel 3 settings and exit the SensaTemp Offset screen.
- **OFF** – The indicator dot will continue BLINKING until a new Temperature Match Offset is input for that channel. Refer to “Tip Heater Cartridge Temperature Match Offset” on page 8.

Press and release the PROGRAM Key ● to proceed to the next step after making your selection.

### **LCD Contrast**

**12.** The display now shows "Set LCD contrast". This setting controls the contrast of the liquid crystal display. The range goes from 0 to 100, with the default being 050.



- Use the keypad (▲▼) to increase or decrease the contrast as needed.
- Press and release the PROGRAM Key ● to proceed to the next step

## LED Backlite

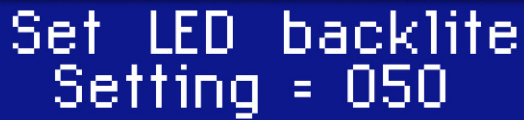

Set LED backlite  
Setting = 050

**13.** The display now reads "Set LED Backlite".

- Use the keypad (▲▼) to increase or decrease the backlite as needed.
- Press and release the PROGRAM Key ● to proceed to the next step

## Exiting Set-Up Mode

**14.** The end is near! If you've been following along on your unit, the display should be showing instructions for saving changes and returning to normal operation, or to discard changes and start the Set-Up over.

- Press and release the Scroll Up Key (▲) to save the changes, exit the Set-Up Menu and return to normal operation.
- Press and release the Scroll Down Key (▼) to return to the start of the Set-Up Menu without saving any changes. Refer to step 3, Password Entry.



Press Up to End  
Down to Restart

## Corrective Maintenance





### Power Source

Most malfunctions are simple and easy to correct.

Symptom	Probable Cause	Solution
No power to system	Blown Fuse	Inspect and replace the fuse(s) located on the power source rear panel
	Line cord unplugged	Plug line cord into the appropriate AC outlet
Heater Assembly does not heat	Open Heater	Contact PACE for assistance
Little or no air flow, heater heats and blower is running	Kinked air hose	Change routing of air hose to remove kinks
Little or no vacuum	Worn vacuum pump	Replace vacuum pump. Contact PACE for assistance.
Unit is turned on, and appears functional but the display is blank	Backlight and/or Contrast settings out of adjustment	Try restoring default display settings by holding the Down Arrow while powering on the unit. If issue is not resolved, contact PACE for assistance.

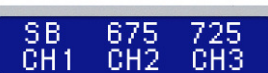

**Display Message Codes**

Display Message	Description
	The incorrect password has been entered. The displayed message will time out after 6 seconds and revert to normal operation. Enter the correct password.
	ISB= Instant SetBack – The handpiece connected to the associated channel has gone into Instant SetBack.
	CHP = Check HandPiece – A handpiece is not connected to the Power Receptacle or is faulty, or the Tip-Heater Cartridge is not properly inserted or faulty.
	OCE = Over Current Error – The Tip-Heater Cartridge circuit is shorted, or the handpiece has failed. Replace the Tip-Heater Cartridge.
	SBk= SetBack – Indicates the unit is in Temperature SetBack mode and has lowered the temperature to prolong tip life by preventing oxidation.

**Spare Parts**

Description	PACE Part Number
Fuse 1.25 Amp, Time Lag (for 120V)	1159-0275-01-P5
Fuse 0.63 Amp, Time Lag (for 230V)	1159-0275-02-P5
MBT Motor/Pump Assembly	1336-0083-P1
Motor/Pump Rebuild Kit	6993-0260-P1
Optional under shelf mounting bracket	1321-0609-P1

## Optional AccuDrive® Blue Series Tip-Heater Cartridges

For optimum thermal performance, always select the shortest, widest tip with the maximum contact surface area with which you can safely access the work.

### Standard Tips



For delicate micro-soldering to challenging, high thermal mass applications

Tip	Description	Part Number	Tip	Description	Part Number
	1/32" Conical Sharp Extended (0.80mm)	P/N 1130-0001-P1		1/16" 30° Chisel (1.59mm)	P/N 1130-0019-P1
	1/64" Conical Sharp (0.40mm)	P/N 1130-0002-P1		1/8" 90° Chisel (3.18mm)	P/N 1130-0020-P1
	1/64" Conical Sharp Bent 30° (0.40mm)	P/N 1130-0003-P1		1/16" 30° Bent Chisel (1.59mm)	P/N 1130-0026-P1
	1/64" Conical Sharp Extended (0.40mm)	P/N 1130-0004-P1		MiniWave® (3.05mm)	P/N 1130-0032-P1
	3/64" 30° Chisel (1.20mm)	P/N 1130-0008-P1		Angled MiniWave® (3.05mm)	P/N 1130-0033-P1
	13/64" Extra Large Chisel (5.15mm)	P/N 1130-0010-P1		Angled MiniWave® (2.11mm)	P/N 1130-0035-P1
	1/64" 60° Bevel (0.40mm)	P/N 1130-0011-P1		1/128" Conical (0.20mm)	P/N 1130-0036-P1
	1/32" 30° Chisel (0.80mm)	P/N 1130-0012-P1		1/4" Flat Blade (6.35mm)	P/N 1130-0037-P1
	3/32" 30° Chisel (2.38mm)	P/N 1130-0013-P1		1/128" Conical, Special (0.20mm)	P/N 1130-0050-P1
	3/64" 30° Bent Chisel (1.20mm)	P/N 1130-0016-P1		1/8" 30° Chisel (3.18mm)	P/N 1130-0051-P1

### Ultra-Performance Tips



Optimized tip geometries and increased thermal pipeline deliver maximum heat throughput

Tip	Description	Part Number	Tip	Description	Part Number
	1/32" Conical Sharp Ext. (0.80mm)	P/N 1131-0001-P1		1/8" 30° Chisel (3.18mm)	P/N 1131-0051-P1
	1/64" Conical Sharp (0.40mm)	P/N 1131-0002-P1		1/16" Chisel (1.59mm)	P/N 1131-0052-P1
	1/64" Conical Sharp Bent 30° (0.40mm)	P/N 1131-0003-P1		1/8" Chisel (3.18mm)	P/N 1131-0053-P1
	3/64" 30° Chisel (1.20mm)	P/N 1131-0008-P1		3/16" Chisel (4.78mm)	P/N 1131-0054-P1
	13/64" Chisel (5.15mm)	P/N 1131-0010-P1		1/4" Chisel (6.35mm)	P/N 1131-0055-P1
	1/32" 30° Chisel (0.80mm)	P/N 1131-0012-P1		9/32" Chisel (7.14mm)	P/N 1131-0056-P1
	3/32" 30° Chisel (2.38mm)	P/N 1131-0013-P1		5/16" Chisel (7.95mm)	P/N 1131-0057-P1
	1/16" 30° Chisel (1.59mm)	P/N 1131-0019-P1			
	MiniWave® (3.05mm)	P/N 1131-0032-P1			
	1/4" Knife Blade (6.35mm)	P/N 1131-0037-P1			

### Service

Please contact PACE or your local distributor for service and repair.

## **PACE LIMITED WARRANTY STATEMENT**

### **Limited Warranty**

Seller warrants to the first user that products manufactured by it and supplied hereunder are free of defects in materials and workmanship for a period of one (1) year from the date of receipt by such user. This Warranty as applied to blowers, motor pumps, x-ray tubes, lenses, optical/lighting probes and cameras is limited to a period of six (6) months. Monitors, computers, and other brand equipment supplied but not manufactured by PACE are covered under their respective manufacturer's warranty in lieu of this Warranty.

This warranty does not cover wear and tear under normal use, repair or replacement required as a result of misuse, improper application, mishandling or improper storage. Consumable items such as tips, heaters, filters, etc. which wear out under normal use are excluded. Failure to perform recommended routine maintenance, alterations or repairs made other than in accordance with Seller's directions, or removal or alteration of identification markings in any way will void this warranty. This warranty is available only to the first user, but the exclusions and limitations herein apply to all persons and entities.

**SELLER MAKES NO OTHER WARRANTY, EXPRESS OR IMPLIED, AND MAKES NO WARRANTY OF MERCHANTABILITY OR FITNESS FOR A PARTICULAR PURPOSE.**

Seller will, at its option, repair or replace any defective products at its facility or other locations approved by it at no charge to user, or provide parts without charge for installation by the user in the field at user's expense and risk. User will be responsible for all costs of shipping equipment to Seller or other location for warranty service.

**EXCEPT FOR THE REMEDY ABOVE DESCRIBED, UNLESS OTHERWISE REQUIRED BY APPLICABLE LAW, SELLER WILL HAVE NO OTHER OBLIGATION WITH REGARD TO ANY BREACH OF WARRANTY OR OTHER CLAIM WITH RESPECT TO THE PRODUCTS, OR LIABILITY FOR ANY DIRECT, INDIRECT, CONSEQUENTIAL, OR INCIDENTAL LOSS OR DAMAGE CAUSED BY OR OCCURRING IN CONNECTION WITH ANY OF THE PRODUCTS.**

Warranty service may be obtained by contacting the appropriate PACE Company or local Authorized PACE distributor as set forth below to determine if return of any item is required, or if repairs can be made by the user in the field. Any warranty or other claim with respect to the products must be made with sufficient evidence of purchase and date of receipt, otherwise user's rights under this warranty shall be deemed waived.

PACE Incorporated retains the right to make changes to specifications contained herein at any time, without notice. Contact your local authorized PACE Distributor or PACE Incorporated to obtain the latest specifications.

The following are trademarks and/or service marks of PACE, Incorporated Vass, NC USA: AccuDrive®, Arm-Evac®, Cir-Kit®, ConducTweez™, Flo-D-Sodr®, HandiPik™, IntelliHeat®, LapFlo™, Mini-Wave®, MiniTweez®, PACE®, PACE EUROPE®, PACE WORLDWIDE®, PACENTER®, Pik-Tip®, PikVac™, Redi-Rak™, ResisTweez™, SensaTemp®, SMR®, Snap-Vac®, SodrTek®, Sodr-X-Tractor®, StripTweez™, Thermo-Drive®, ThermoFlo®, ThermoJet®, ThermoPart™, ThermoPik™ and ThermoTweez®, VisiFilter™.

PACE products meet or exceed all applicable military and civilian EOS/ESD, temperature stability and other specifications including MIL STD 2000, ANSI/JSTD 001, IPC7711, and IPC A-610.



**PACE Incorporated  
346 Grant Road  
Vass, NC 28394**

**Tel: (877) 882-PACE  
Tel: (910) 695-7223  
Fax: (910) 695-1594**