



RX-8152

Ergo™ Ultra-Flush® Precision Cut Diagonal Cutter with Oval Head 0.2-1.25 mm







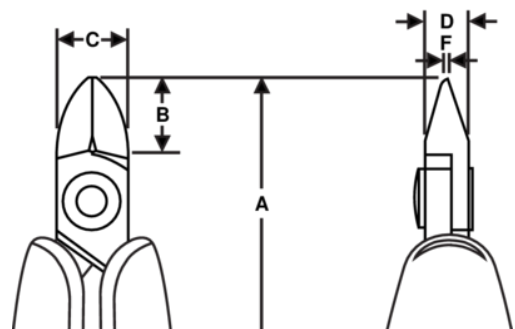

PRODUCT DETAILS

- Ideal for cutting leads, jewelry wire, and general assembly applications
- Two-component ESD safe Ergo™ handles: Thermoplastic surface on tough polypropylene provides superior grip
- Material: High performance alloy steel
- Precision induction hardened cutting edges 63–65 HRC
- Micro-Touch™: The shape of the handles makes it possible to control and rotate the pliers between thumb and index finger for precision work
- Precision screw joint minimizes friction and maximizes alignment of cutting edges
- Biospring® reduces tension throughout the working cycle of the tool and can be adjusted in three different positions
- Cutting capacity is listed for solid copper wire
- Burnished finish



PRODUCT ATTRIBUTES

Product: **RX-8152**

| | | | | | |
|---|-------------|---|--------------|---|---------------|
|  | Oval |  | M | A | 138.0 mm |
| A | 5.43 in | B | 13 mm | B | 0,51 in |
| C | 12,5 mm | C | 0.49 in | D | 6 mm |
| D | 0,24 inch | F | 1,2 mm | F | 0,05 in |
|  | 0.2-1.25 mm |  | 0.00-0.05 in |  | Ultra-Flush ® |
|  | 73 g | Ω | Dissipative | | |