



## RX-8140

### Ergo™ Micro-Bevel® Precision Cut Diagonal Cutter with Oval Head 0.2-1.25 mm







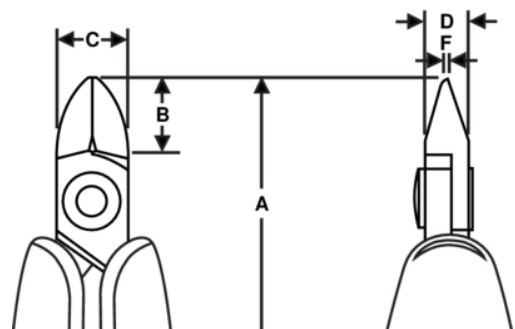

#### PRODUCT DETAILS

- Ideal for cutting leads, jewelry wire, and general assembly applications
- Two-component ESD safe Ergo™ handles: Thermoplastic surface on tough polypropylene provides superior grip
- Material: High performance alloy steel
- Precision induction hardened cutting edges 63–65 HRC
- Micro-Touch™: The shape of the handles makes it possible to control and rotate the pliers between thumb and index finger for precision work
- Precision screw joint minimizes friction and maximizes alignment of cutting edges
- Biospring® reduces tension throughout the working cycle of the tool and can be adjusted in three different positions
- Cutting capacity is listed for solid copper wire
- Burnished finish



## PRODUCT ATTRIBUTES

Product: **RX-8140**

	Oval		S	<b>A</b>	135.5 mm
<b>A</b>	5.33 in	<b>B</b>	10,5 mm	<b>B</b>	0,41 in
<b>C</b>	10 mm	<b>C</b>	0.39 in	<b>D</b>	6 mm
<b>D</b>	0,24 inch	<b>F</b>	0,8 mm	<b>F</b>	0,03 in
	0.2-1.25 mm		0.00-0.05 in		Micro-Bevel ®
	70 g	<b>Ω</b>	Dissipative		