

Face Recognition Terminal Installation and Operation Instructions



Figure 1. EMIT 50748 Face Recognition Terminal with Turnstile Mounting Kit

Packaging

- 1 Face Recognition Terminal
- 1 Back Plate for Turnstile
- 1 Back Plate for Wall Mount
- 1 Mounting Post
- 1 Mounting Bracket
- 1 Wiegand-to-USB Converter
- 1 USB Cable, 6 ft.
- 1 Power Adapter with North American Power Cord
- 1 Nut
- 2 Hex Head Screws
- 5 Torx Head Screws
- 1 Torx Screwdriver
- 3 Dual Lock Fastener Set, 2" Length
- 10 Zip Ties
- 10 Cable Tie Mounts

Description

The EMIT 50748 Face Recognition Terminal is designed to be used with the SmartLog Pro®* to test operators that wear foot grounders or wrist straps. The biometric reader uses facial features to identify the operator and can be set to limit access based on the operator's temperature or if the operator is wearing a mask. Verified scans override the test switch on the personnel tester and allow operators to perform tests without contact. Contactless tests are only compatible with dual-wire (conductor) wrist straps and operators wearing two foot grounders. The 50748 Face Recognition Terminal includes all of the necessary hardware for mounting it onto a turnstile.

*The Face Recognition Terminal is compatible with both the SmartLog Pro® and SmartLog Pro® SE.

Installation

Preparing the Turnstile

The Face Recognition Terminal requires a 1.375" (35 mm) hole in order to be mounted onto a turnstile. Locate the hole wherever there is clearance behind the SmartLog Pro®, so the Face Recognition Terminal does not obstruct access to its controls once installed.

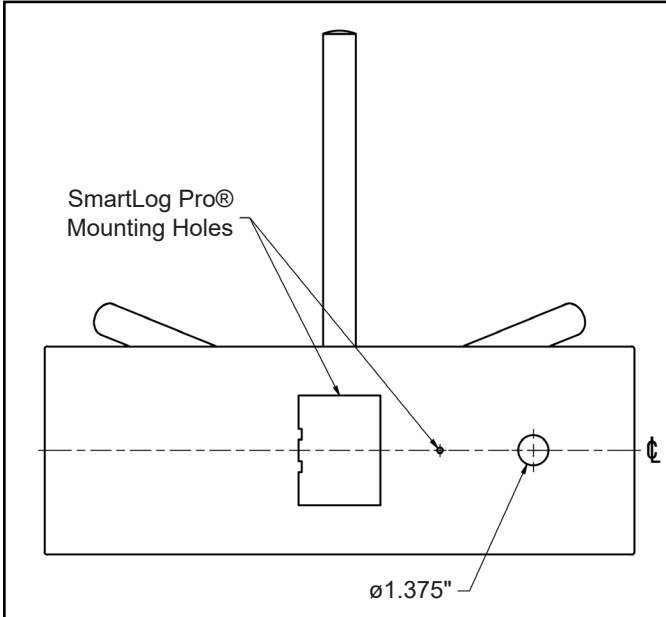

Figure 2. Mounting hole diameter for the Face Recognition Terminal's mounting post (inches)

Installing the Face Recognition Terminal

1. Insert the mounting post into the 1.375" (35 mm) hole on the turnstile's lid.



Figure 3. Inserting the mounting post into the hole in the turnstile's lid

2. Use the nut to secure the mounting post onto the turnstile's lid. Tighten the nut using fingers only, so the post may be swiveled freely for the remainder of the installation procedure.



Figure 4. Using the nut to secure the mounting post onto the turnstile's lid

3. Feed the black and red wire harness from the Wiegand-to-USB Converter through the mounting post. Leave the ends of the harness sticking out of the mounting post on the top-side of the turnstile.



Figure 5. Feeding the wire harness from the Wiegand-to-USB Converter through the mounting post



Figure 6. Routing the wire harness out the mounting post

4. Install the mounting bracket to the mounting post using the two hex head screws.

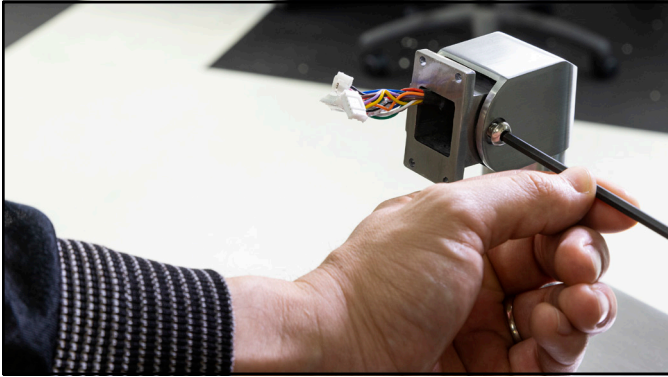

Figure 7. Securing the mounting bracket to the mounting post

5. Secure the back plate onto the mounting bracket using four Torx head screws.



Figure 8. Securing the back plate to the mounting bracket

6. Connect the wire harness to the receptacles on the back of the Face Recognition Terminal.



Figure 9. Connecting the wire harness to the Face Recognition Terminal

7. Connect the Face Recognition Terminal to the back plate and secure its installation by installing a Torx head screw at the bottom.



Figure 10. Securing the Face Recognition Terminal to the back plate

8. Use two of the dual lock fastener sets to adhere the Wiegand-to-USB Converter onto the inside of the turnstile's lid.



Figure 11. Mounting the Wiegand-to-USB Converter onto the turnstile's lid

9. Connect the green plug on the Wiegand-to-USB Converter's red and white wire harness to the SmartLog Pro®.

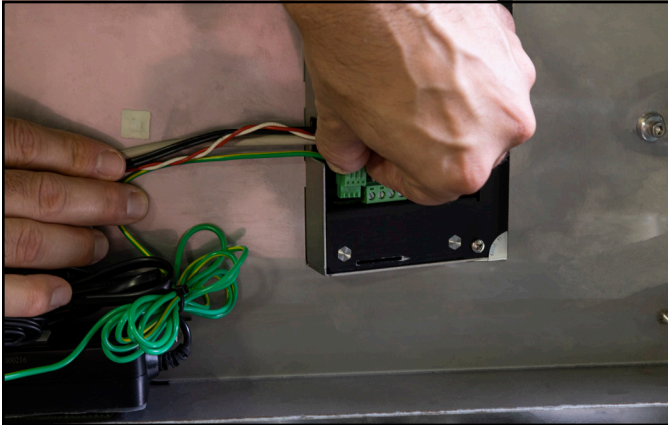

Figure 12. Connecting the green plug from the Wiegand-to-USB Converter to the SmartLog Pro®

10. Connect one end of the USB cable to the SmartLog Pro®.



Figure 13. Connecting the USB cable to the SmartLog Pro®

11. Connect the opposite end of the USB cable to the Wiegand-to-USB Converter.



Figure 14. Connecting the USB cable to the Wiegand-to-USB Converter

12. Plug the Face Recognition Terminal's power adapter into the power jack pig-tailed to the Wiegand-to-USB Converter.

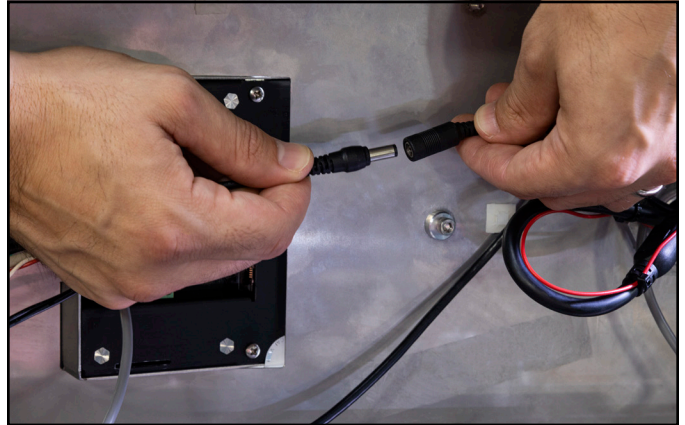

Figure 15. Connecting the power adapter to the Wiegand-to-USB Converter

13. Use a dual lock fastener set to adhere the power adapter onto the inside of the turnstile's lid.

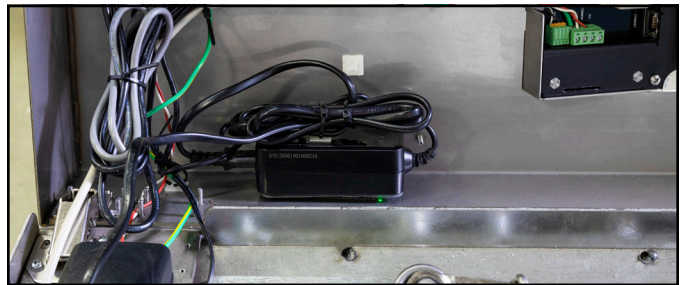

Figure 16. Mounting the power adapter onto the the turnstile's lid

14. Use the cable tie mounts and zip ties to organize all cables and keep them from touching any moving parts inside the turnstile's cabinet.

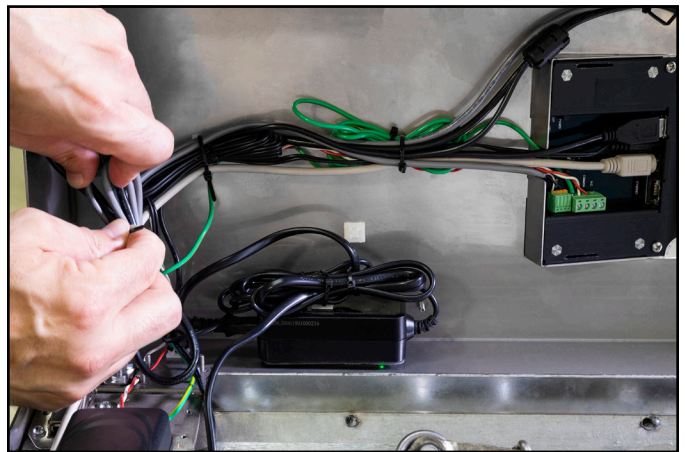

Figure 17. Organizing the cables

15. Plug the power adapter into an electrical receptacle inside the turnstile.

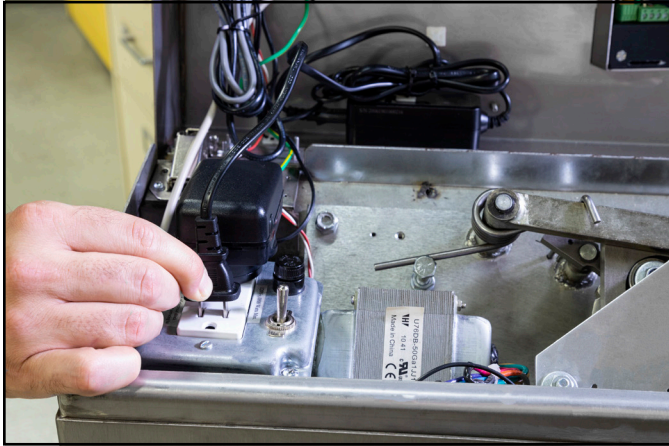

Figure 18. Connecting the power adapter to an electrical receptacle inside the turnstile

16. Swivel the Face Recognition Terminal to face the proper direction and tighten its mounting nut using a hand tool.

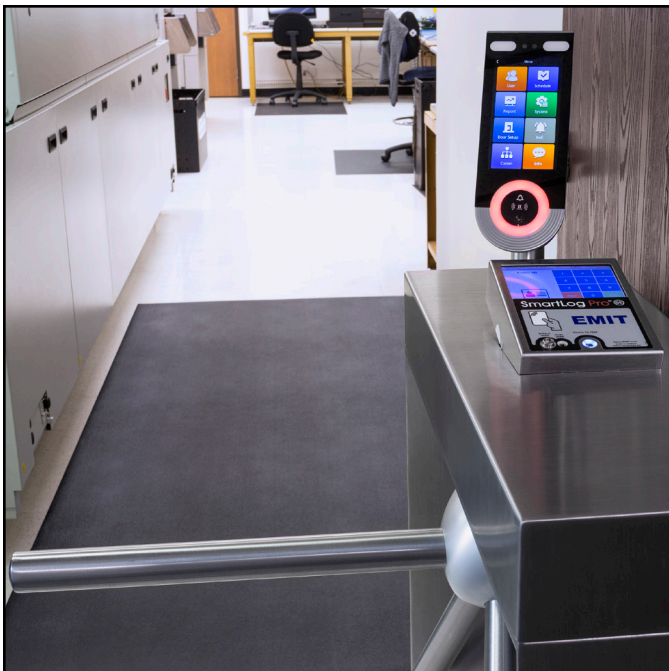

Figure 19. Completing the installation

Operation

[Click here](#) to download the user manual for the Face Recognition Terminal and learn how to operate its user interface. When enrolling new users, be sure to enter the same number as the TEST ID utilized in the SmartLog Pro® Manager Web App or TEAM6 Software.

The Face Recognition Terminal has the ability to initiate and conduct contactless tests. Contactless tests are only compatible with dual-wire (conductor) wrist straps and operators wearing two foot grounders. Use the SmartLog Pro® Manager Web App or TEAM6 Software to configure the required tests in the SmartLog Pro® terminals appropriately prior to dispatching the Face Recognition Terminal.

1. A circling light around the test switch indicates when the SmartLog Pro® is on standby and ready to perform a test.
2. When performing a footwear test, be sure to place both feet on the dual foot plate (one foot per plate).

NOTE: Keep the foot plate clean with 99% isopropyl alcohol when using the 1 Gigohm high test limit. A dirty foot plate could yield a false pass.

When performing a dual-wire wrist strap test, be sure to completely plug in the wrist cord into the tester's jack.

3. Initiate the test by moving into the camera's line-of-sight. The terminal will determine if the operator is already enrolled, has an acceptable body temperature, and is wearing a face mask (if enabled). The test results will display on the SmartLog Pro® when the test is completed.

NOTE: Do not touch any other metal surfaces while performing the test as this will affect the results.

4. The relay terminal will activate and unlock the turnstile if the defined tests are passed.

NOTE: Failures may be caused by dry skin or minimal sweat layer. For wrist straps, try using an approved dissipative hand lotion such as [Menda Reztore® ESD Hand Lotion](#) prior to use. Footwear test results can be improved by taking a short walk to build a sweat layer for better conductivity.

5. Pass through the turnstile. The turnstile will re-lock after one rotation.



Figure 20. Using the Face Recognition Terminal to identify an operator



Figure 21. Using the Face Recognition Terminal to identify an operator and enforce the wearing of a face mask

Specifications

Input Voltage and Frequency (External Adapter)	AC/DC Power Adapter Power Input: 100-240VAC, 50/60 Hz Power Output: 12 VDC, 2 A Cable Length: 8 ft. (2.4 m) total
Operating Temperature	50 to 158° F (10 to 70° C)
Environmental Requirements	Indoor use only at altitudes less than 6500 ft. (2 km) 10-90% RH
Dimensions	9.1" x 3.5" x 1.0" (232 mm x 88 mm x 25 mm)
Weight	1.1 lbs (0.5 kg)
Face Capacity	20,000
Available Detections	Liveness, Body Temperature, Mask
Available Languages	English, Spanish, Japanese, Chinese (Simplified & Traditional), French, Russian, Portuguese, Italian, Korean, Thai, Arab, Vietnamese
Country of Origin	China

Limited Warranty, Warranty Exclusions, Limit of Liability and RMA Request Instructions

See the EMIT Warranty - DescoEMIT.com/Warranty.aspx