

visioneng.us

High definition digital microscope **EVO CAM II**

Industry experience includes:
Medical, Electronics & Precision engineering



EVO Cam II high definition digital microscope

EVO Cam II digital microscope delivers excellent image quality to help uncover hidden details. Optical magnification up to 300x and full autofocus to ensures ultra-sharp images at all times.

EVO Cam II provides the ability to measure complex parts efficiently and quickly using overlays or point to point measurement.

Capture high resolution images at the touch of a button either direct to USB memory stick, via wireless or direct to a PC.

10 programmable presets allows camera settings be saved for quick and easy recall. Presets can be exported and imported allowing users to share settings between units and sites ensuring consistency of inspection. Calibration can also be saved in presets for quick recall.



Highlights

- Ultra-sharp image quality with full autofocus
- Optical magnification range 1.7x -300x
- Maximum magnification with digital zoom 3600x
- Fast 60 fps provides clear images without motion blur
- Full 360° inspection without the need to manipulate subjects under magnification
- Large field of view and long working distances
- Eliminate set-up time with up to 10 presets
- Custom overlays to aid inspection
- Wi-Fi and USB 3.0 for fast image transfer
- Efficient dimensioning with virtual caliper and scalable grids

Ease of use

Simplicity is at the heart of EVO Cam II. Easy to follow menu and simple operation minimizes training and is an ideal solution for multiple users in high speed production environments.

An overview function allows you easily locate a point of interest on the object you are viewing.

The on-screen function menu for the EVO Cam II is also available in multiple languages.

In addition to the convenient operation of all main functions on the unit, a remote control console allows faster and more comfortable use.





Making image capture and documentation simpler, faster and more reliable - whenever ultra sharp images are required for inspection, fault analysis and much more.

Optics & Illumination



Precision objective lenses

Ultra-high resolution and contrast, optimized for precision magnification work with definition excellence.

Wide-field objective lenses

Wide field of view, suited for larger subjects. An extra long working distance provides maximum flexibility and large zoom range for flexible operations. Suitable for larger subjects.

A range of objective lens options ensure stunning results for any application, whether for high magnification, high precision detail inspections, or for manipulation, re-work and assembly tasks requiring an extra long working distance.

Objective lens	Magnification zoom range*	Working distance	Field of view at min. zoom	Field of view at max. zoom
Precision objective lenses				
0.45x	2.3x - 68x	6.30" (160mm)	9.48" x 5.27" (241mm x 134mm)	0.31" X 0.17" (7.8mm x 4.2mm)
0.62x	3.1x - 93.7x	4.17" (106mm)	6.81" x 3.78" (173mm x 96mm)	0.22" x 0.12" (5.5mm x 3.1mm)
1.0x	5x - 151.2x	3.35" (85mm)	3.46" x 2.24" (88mm x 57mm)	0.14" x 0.08" (3.5mm x 2mm)
1.5x	7.6x - 226.8x	1.69" (43mm)	1.77" x 1.41" (45mm x 36mm)	0.09" X 0.05" (2.3mm x 1.2mm)
2.0x	10x - 302.4x	1.14" (29mm)	1.45" x 1.06" (37mm x 27mm)	0.06" x 0.04" (1.5mm x 1.0mm)
Wide-field objective lenses				
4 diopter	1.71x - 51.41x	9.65" (245mm)	11.53" x 6.73" (293mm x 171mm)	0.39" x 0.22" (10mm x 5.5mm)
5 diopter	2.12x - 65.5x	7.76" (197mm)	9.13" x 5.31" (232mm x 135mm)	0.31" X 0.18" (8mm x 4.5mm)

*with 24" monitor

Camera zoom	30x optical; 12x digital
Camera resolution	1080p, 1920x1080, 1/2.8" CMOS
Frame rate	50fps & 60fps (switchable)
Output	HDMI & USB 3.0 out
Saved file type	.png

Camera

Auto exposure and aperture priority allow control of target brightness with difficult subjects and enables easy control of depth of field. Selectable gain, iris and exposure time enables full control of image parameters where manual control is desired.



LED ring light

Integral 8-point LED ring light ensures optimum shadow-free illumination for all applications. Color temperature 5500K.

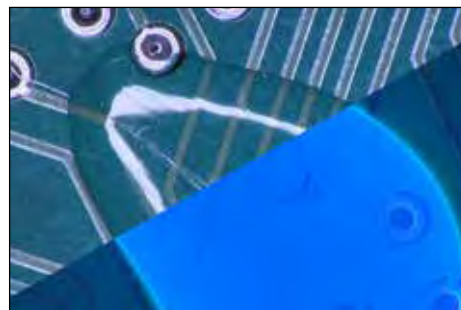

UV ring light

The UV ring light accessory is suitable for many applications ranging from electronics, aerospace and forensics.



Substage illumination

The substage illumination lights a subject from beneath. It is ideal for inspection of translucent materials.

Measurement & Image Transfer

Measurement

EVO Cam II includes easy on-screen measurement capability, with selectable overlays, grid and cursors.

Cursor mode displays two movable horizontal and vertical lines, allowing measurement of X and Y values with results displayed on screen. Also point to point diagonal measurement allows measurement of non-aligned items.

Grids can be displayed, scaled and positioned as required.

Customizable overlays are easily created and imported into the camera allowing easy comparison against drawings, samples or reticules.

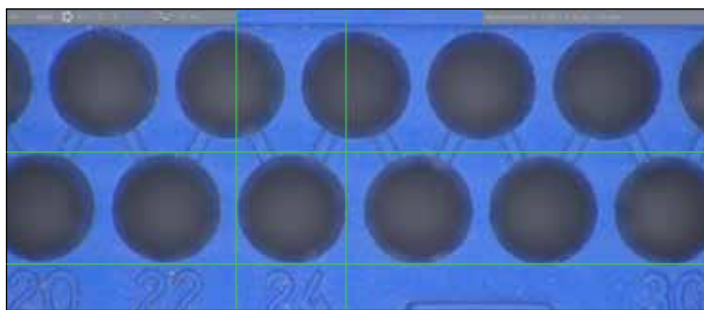

Image Transfer

Images can easily be captured and saved from the EVO Cam II directly to a USB dongle at the touch of a button. Alternatively they can be transferred securely to a computer via cable output (HDMI or USB 3.0) or wirelessly using a Wi-Fi dongle.

Using the Wi-Fi dongle allows users to quickly view and download images and videos, and is ideal for multiple user access.

Software (optional)

EVO Cam II works with a range of straightforward software for easy image capture, on-screen image measurement and documentation.



Remote control console

The remote control console helps to improve user comfort and is a convenient tool to help a user quickly access their presets.



Filters

There are a range of filters available to enhance details within subjects not easily seen.



Floating stage

A floating stage provides smooth and precise control for checking uniformity of components, or inspecting sensitive samples. *(Ergo/Bench stands only).*

360° rotating viewer

This unique feature offers a full 360° rotating view without the need to move the subject under magnification, making inspection easier and quicker.

The 34° angle allows detail to be seen at the base of any vertical component or feature.

Operators can simply switch between rotating oblique view and a direct view for ultimate flexibility.

- Includes integrated 8-point LED ring light and objective lens

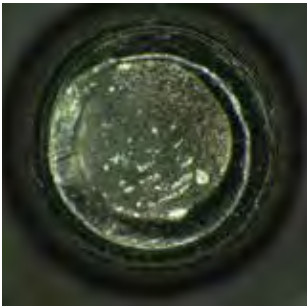

Direct view:

The subject is seen from a birds-eye view.



Rotating oblique view:

The subject can be viewed from a number of angles.

360° rotating view					
Zoom ratio	Zoom range	Working distance	Field of view at min. zoom	Field of view at max. zoom	Viewing angle
5.3:1	19x – 105x	1.40" (35.5mm)	1.01" x 0.87" (25.7mm x 22.1mm)	0.10" x 0.08" (2.6mm x 2.2mm)	34° from vertical

Direct view					
Zoom ratio	Zoom range	Working distance	Field of view at min. zoom	Field of view at max. zoom	Viewing angle
5.3:1	28x – 151x	2.22" (56.5mm)	0.77" x 0.44" (19.7mm x 11.2mm)	0.06" x 0.03" (1.6mm x 0.9mm)	-



Stand options

Multi-axis stand

- Precise and robust, ideal for industrial applications where maximum work space is desired.
- Integrated gas strut provides counter balanced adjustability, making operation quick and effortless. Switch between tall components and flat samples with ease.
- Available with platform base, or mounted directly to the work surface.

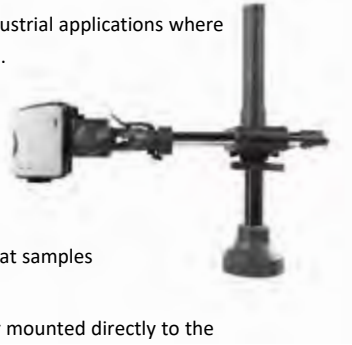

Ergo stand

- Small footprint providing exceptional stability for high magnification use.
- Transmitted substage illumination option permits viewing of a wider range of sample types.
- Floating stage option provides sensitive control for accurate inspection of samples; ideal for inspecting fragile samples, or for avoiding contamination by handling.
- Coarse and fine focus counter for high magnification subjects



Double-arm boom stand

- Designed specifically for applications requiring extended reach, without compromising stability.
- Easy adjustability allows precise positioning and alignment.
- Available with platform base, or with clamp for mounting directly to the work surface.



Articulated arm stand

- Designed for applications requiring extended reach, with ultimate flexibility.
- Multi-point adjustability allows precise positioning and alignment.



Single-arm boom stand

- High stability boom stand, ideal for larger specimens.
- Robust stand option, complete with heavy duty platform base and focus module.



Bench stand

- Compact unit with low-profile base and integral transmitted substage illumination.
- Floating stage option provides sensitive control for accurate inspection of samples.
- For use with 1.0x objective.

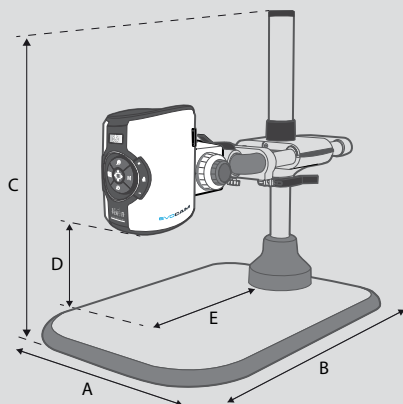

Multi-axis stand dimensions:

- A = 17.9" (455mm), 7.2"(184mm)**
- B = 26.9" - 32.7" (682mm - 830mm)
- C = 27.2" (691mm) max.
- D = 11" (279mm) max.
- E = 17.3" (439mm) max.

** without platform base.

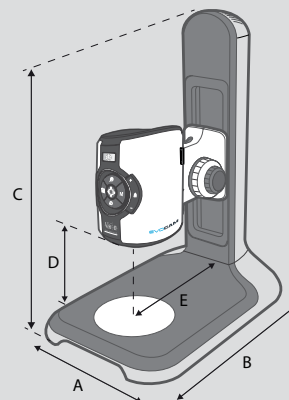

Ergo stand dimensions:

- A = 11" (280mm)
- B = 16.5" (420mm)
- C = 20.3" (515mm)
- D = 7.6" (192mm) max.
- E = 7.9" (200mm)

Vision Engineering is a global manufacturer of ergonomic stereo microscopes, digital inspection systems and optical and video measuring systems.

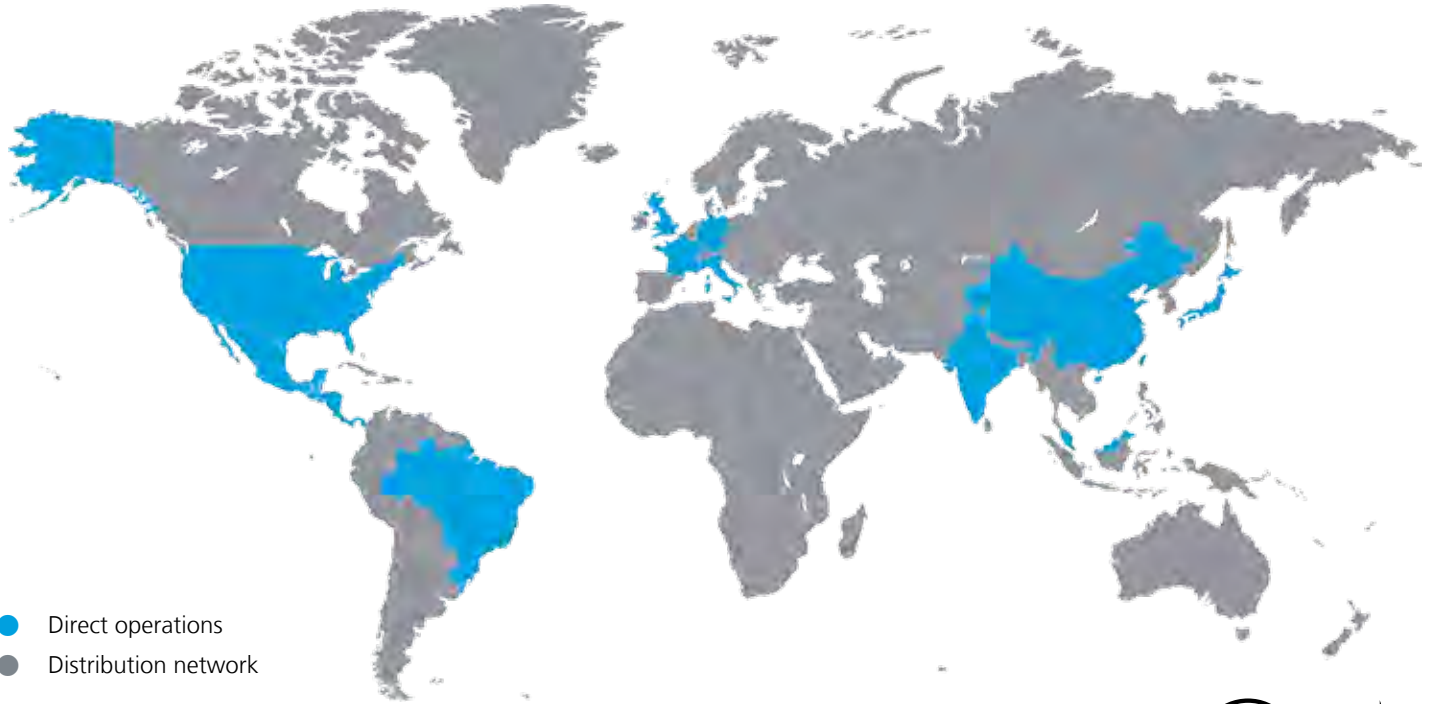

- Direct operations
- Distribution network



Vision Engineering Inc. ha sido certificada para el sistema de gestión de calidad ISO 9001:2015.

For more information

For more information, please contact your Vision Engineering branch, local authorized distributor, or visit our website.

Distributor

Vision Engineering Ltd.
(UK Manufacturing & Commercial)
The Freeman Building, Galileo Drive,
Send, Surrey, GU23 7ER, UK
Tel: +44 (0) 1483 248300
Email: generalinfo@visioneng.com

Vision Engineering Ltd.
(Italia)
Via G. Paisiello 106
20092 Cinisello Balsamo MI, Italia
Tel: +39 02 6129 3518
Email: info@visioneng.it

Vision Engineering
(South East Asia)
P-03A-20, Impian Meridian,
Jalan Subang 1,
USJ 1, 47600 Subang Jaya,
Selangor Darul Ehsan, Malaysia
Tel: +604-619 2622
Email: info@visioneng.asia

Vision Engineering
(Mexico)
Tel: +01 800 099 5325
Email: info@visioneng.com

Vision Engineering Inc.
(NA Manufacturing & Commercial)
570 Danbury Road,
New Milford, CT 06776, USA
Tel: +1 (860) 355 3776
Email: info@visioneng.de

Vision Engineering Ltd.
(France)
ZAC de la Tremblaie,
Av. de la Tremblaie
91220 Le Plessis Paté, France
Tel: +33 (0) 160 76 60 00
Email: info@visioneng.fr

Vision Engineering
(China)
Room 904B, Building B, No.970,
Nanning Road, Xuhui Vanke Center
Shanghai, 200235, P.R. China
Tel: +86 (0) 21 5036 7556
Email: info@visioneng.com.cn

Vision Engineering
(Brazil)
Email: info@visioneng.com.br

Vision Engineering Ltd.
(Central Europe)
Anton-Pendele-Str. 3,
82275 Emmering, Deutschland
Tel: +49 (0) 8141 40167-0
Email: info@visioneng.de

Nippon Vision Engineering
(Japan)
272-2 Saedo-cho, Tsuduki-ku,
Yokohama-shi, 224-0054, Japan
Tel: +81 (0) 45 935 1117
Email: info@visioneng.jp

Vision Engineering
(India)
Tel: +91 (0) 80-5555-33-60
Email: info@visioneng.co.in

Disclaimer – Vision Engineering Ltd. has a policy of continuous development and reserves the right to change or update, without notice, the design, materials or specification of any products, the information contained within this brochure/data sheet and to discontinue production or distribution of any of the products described.

